

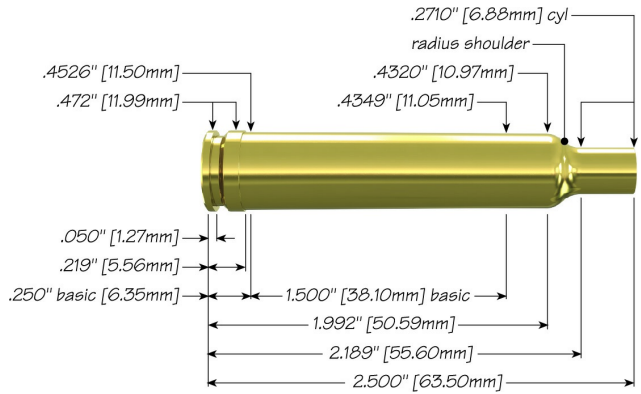

240 Weatherby Magnum with 85 gr Spitzer BTSP



Max Case Length:	2.500"
Trim-to Length:	2.490"
Max Cart. OAL:	3.100"
RCBS Shell Holder:	# 3
Test Firearm:	Universal Receiver
Barrel Length:	24"



6mm	Speer Part No.	Weight, grains	COAL Tested	Ballistic Coefficient	Sectional Density
	85 gr Spitzer BTSP 1213	85	3.060"	.380	.206

Propellant	Cartridge Case	Primer	START CHARGE		MAXIMUM CHARGE	
			Grain	Velocity (ft/sec)	Grain	Velocity (ft/sec)
Hodgdon H380	Weatherby	CCI 250	43.0	2949	47.0	3236
Hodgdon H414	Weatherby	CCI 250	48.0	3161	52.0	3430
IMR 4064	Weatherby	CCI 250	40.0	2976	44.0	3242
IMR 4350	Weatherby	CCI 250	47.5	3162	51.5	3417
IMR 4831	Weatherby	CCI 250	49.0	3304	53.0 C	3473
Winchester 760	Weatherby	CCI 250	46.0	3071	50.0	3349

C = Compressed Load